

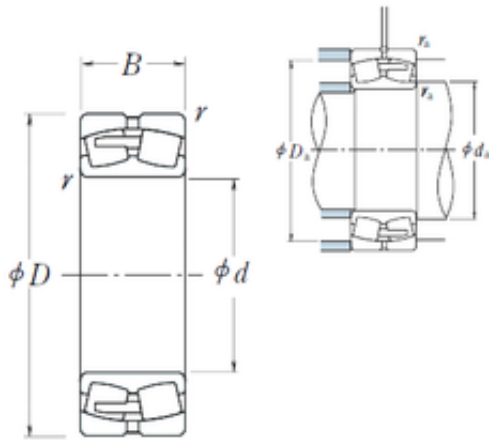

Bearing Import and Export Co., Ltd.

231/670CAE4 NSK Spherical Roller Bearing



Bearing No. 231/670CAE4

Size	670x1090x336 mm
Bore Diameter	670 mm
Outer Diameter	1090 mm
Width	336 mm
d	670 mm
D	1090 mm
B	336 mm
C	336 mm
r min.	7,5 mm
da min.	706 mm
Da min	952 mm
Da max.	1054 mm
ra max.	6 mm
Weight	1230 Kg
Basic dynamic load rating (C)	10600 kN
Basic static load rating (C0)	21600 kN
(Grease) Lubrication Speed	190 r/min
(Oil) Lubrication Speed	240 r/min
Calculation factor (e)	0,3
Calculation factor (Y0)	2,2
Calculation factor (Y2)	3,3

231/670CAE4 Bearing 2D drawings and 3D CAD models