

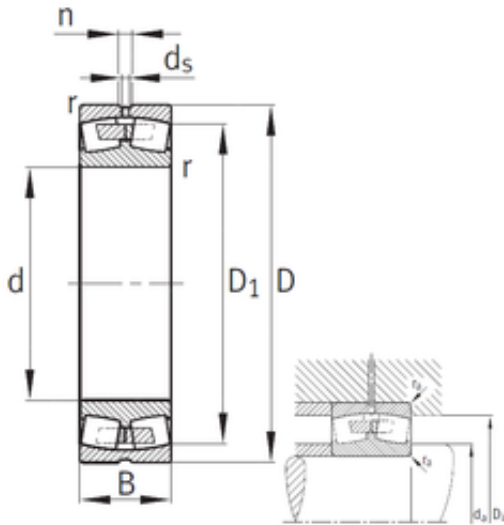

Bearing Import and Export Co., Ltd.



360 mm x 540 mm x 180 mm FAG 24072-B-MB Spherical roller bearings

Bearing No. 24072-B-MB

Size	360x540x180 mm
Bore Diameter	360 mm
Outer Diameter	540 mm
Width	180 mm
d	360 mm
D	540 mm
B	180 mm
C	180 mm
n	17,7 mm
r min.	5 mm
D1	478,5 mm
da min.	378 mm
Da max.	522 mm
ra max.	4 mm
d5	9,5 r/min
Weight	138 Kg
Basic dynamic load rating (C)	3250 kN
Basic static load rating (C0)	6800 kN
Fatigue load limit (Pu)	530
Reference speed	560 r/min
Limiting speed	800 r/min
Calculation factor (e)	0,33
Calculation factor (Y0)	2,01
Calculation factor (Y1)	2,06

24072-B-MB Bearing 2D drawings and 3D CAD models