

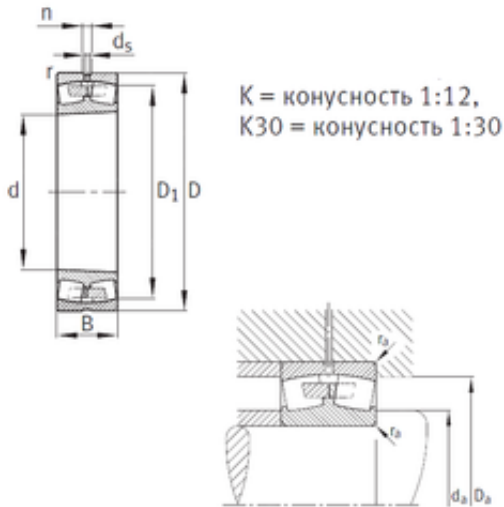

## Bearing Import and Export Co., Ltd.



### 320 mm x 580 mm x 208 mm FAG 23264-K-MB Spherical roller bearings

Bearing No. 23264-K-MB

Size	320x580x208 mm
Bore Diameter	320 mm
Outer Diameter	580 mm
Width	208 mm
d	320 mm
D	580 mm
B	208 mm
C	208 mm
n	23,5 mm
r min.	5 mm
D1	489,6 mm
da min.	340 mm
Da max.	560 mm
ra max.	4 mm
d5	12,5 r/min
Weight	229 Kg
Basic dynamic load rating (C)	3900 kN
Basic static load rating (C0)	6950 kN
Fatigue load limit (Pu)	330
Reference speed	510 r/min
Limiting speed	950 r/min
Calculation factor (e)	0,37
Calculation factor (Y0)	1,76
Calculation factor (Y1)	1,8

23264-K-MB Bearing 2D drawings and 3D CAD models